

JVC

MULTI-FORMAT MONITOR

DT-V100CG

INSTRUCTIONS

The supplied wide mask is attached to the monitor in the illustration on the right.

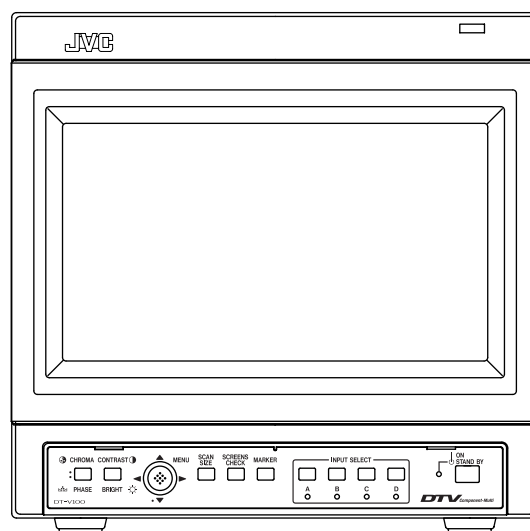

Thank you for purchasing this JVC Multi-Format Monitor. Before using it, read and follow all instructions carefully to take full advantage of the monitor's capabilities.

SAFETY PRECAUTIONS

In order to prevent any fatal accidents caused by misoperation or mishandling the monitor, be fully aware of all the following precautions.

WARNINGS

To prevent fire or shock hazard, do not expose this monitor to rain or moisture. Dangerous high voltages are present inside the unit. Do not remove the back cover of the cabinet. When servicing the monitor, consult qualified service personnel. Never try to service it yourself.

WARNING : THIS APPARATUS MUST BE EARTHED.

Improper operations, in particular alternation of high voltage or changing the type of tube may result in x-ray emission of considerable dose. A unit altered in such a way no longer meets the standards of certification, and must therefore no longer be operated.

This monitor is equipped with a 3-blade grounding-type plug to satisfy FCC rule. If you are unable to insert the plug into the outlet, contact your electrician.

WARNING

This is a class A product. In a domestic environment this product may cause radio interference in which case the user may be required to take adequate measures.

FCC NOTICE (U.S.A. only)

CAUTION: Changes or modifications not approved by JVC could void the user's authority to operate the equipment.

NOTE: This equipment has been tested and found to comply with the limits for a Class A digital device, pursuant to Part 15 of the FCC Rules. These limits are designed to provide reasonable protection against harmful interference when the equipment is operated in a commercial environment. This equipment generates, uses, and can radiate radio frequency energy and, if not installed and used in accordance with the instruction manual, may cause harmful interference to radio communications. Operation of this equipment in a residential area is likely to cause harmful interference in which case the user will be required to correct the interference at his own expense.

Notice (U.S.A. only)

This product utilizes both a Cathode Ray Tube (CRT) and other components that contain lead. Disposal of these materials may be regulated in your community due to environmental considerations. For disposal or recycling information please contact your local authorities, or the Electronics Industries Alliance: <<http://www.eiae.org>>

■ PRECAUTIONS

- Use only the power source specified on the unit. (120 V/220-240 V AC, 50 Hz/60 Hz)
- Keep flammable material, water, and metal objects away from the unit – especially the interior of the unit.
- This unit incorporates high voltage circuitry. For your own safety and that of your equipment, do not attempt to modify or disassemble this monitor. There are no user-serviceable parts inside.

■ HANDLING

- Avoid shocks or vibrations. These may damage the unit and cause it to malfunction.
- Do not block the ventilation slots.
- Do not expose this unit to high temperatures. Extended exposure to direct sunlight or a heater could deform the cabinet or cause the performance of internal components to deteriorate.
- Do not place the unit near appliances generating strong electric or magnetic fields. There can generate picture noise and instability.
- Keep the monitor clean by wiping the cabinet and CRT screen with a piece of soft cloth. Do not apply thinner or benzine. These chemicals can damage the finish and erase printed letters. When the unit is excessively dirty, use a diluted neutral cleanser, then wipe away the cleanser with a dry cloth.

SCREEN BURN

- It is not recommended to keep a certain still image displayed on screen for a long time as well as displaying extremely bright images on screen. This may cause a burning (sticking) phenomenon on the screen of cathode-ray tube. This problem does not occur as far as displaying normal video playback motion images.

POWER CONNECTION

The power supply voltage rating of this product is AC 120 V (For U.S.A. and Canada only) and AC 220-240 V (For European countries, United Kingdom, or China), the power cord attached conforms to the following power supply voltage and countries. Use only the power cord designated to ensure Safety and EMC regulations of each countries.

Power cord

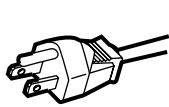

Power supply voltage : AC 120 V
Countries : U.S.A. and Canada

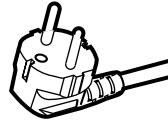

AC 220-240 V
European countries

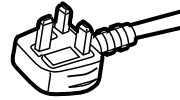

AC 220-240 V
United Kingdom

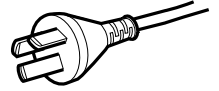

AC 220-240 V
China

Warning:

- Do not use the same Power Cord for AC 120 V as for AC 220-240 V. Doing so may cause malfunction, electric shock or fire.

Note for the United Kingdom power cord only

The plug on the United Kingdom power cord has a built-in fuse. When replacing the fuse, be sure to use only a correctly rated approved type, re-fit the fuse cover.

(Consult your dealer or qualified service personnel.)

How to replace the fuse

Open the fuse compartment with the blade screw driver, and replace the fuse.

(* An example is shown in the illustration.)

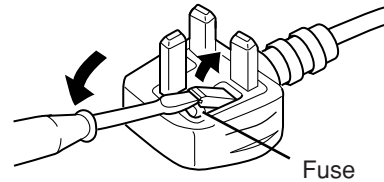

EMC Supplement (Europe only)

This equipment is in conformity with the provisions and protection requirements of the corresponding European Directives. This equipment is designed for professional video appliances and can be used in the following environments:

- Controlled EMC environment (for example purpose built broadcasting or recording studio), and the rural outdoors environment (far away from railways, transmitters, overhead power lines, etc.)

In order to keep the best performance and furthermore for electromagnetic compatibility we recommend to use cables not exceeding the following length:

Cable		Length
Power cord	(attached cable)	2.0 m
Video signal cable	(coaxial cable)	2.0 m
Audio signal cable	(shielded cable)	1.0 m
RS-485 cable	(twist pair cable)	10.0 m

The inrush current of this apparatus is 35 ampere.

Caution

When in case that the strong electromagnetic waves or magnetism is near the audio cable or the signal cable, the sound or the picture will contain noise. In such case, please keep the cable away from the sources of the disturbance.

CONTENTS

SAFETY PRECAUTIONS	2
Controls and Features	4
Preparation	7
Basic Menu Operations	
(MAIN MENU, SET-UP MENU)	9
How to Use MAIN MENU	11
How to Use SET-UP MENU	14
How to Use the External Control	19
Troubleshooting	21
Self-check Indications	22
Specifications	23

Controls and Features

Front Panel

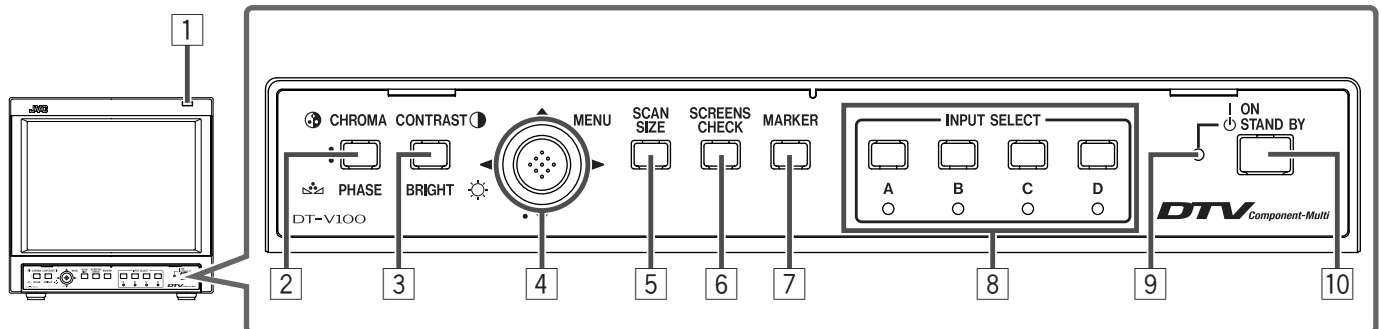

1 Tally lamp

This lamp is controlled by the tally function of the MAKE/TRIGGER terminal.

☞ “How to Use the MAKE/TRIGGER Terminal” on page 19

- You can set the lamp color to red or green in “TALLY SELECT.”
- ☞ “TALLY SELECT” on page 15
- When you set “FORMAT IND.” to “ON,” this lamp works as the format indicator showing the format of the signal currently input.
- ☞ “FORMAT IND.” on page 15

2 CHROMA (🌀)/PHASE (🌈) button

Activates the Chroma (picture color density) adjustment mode or the Phase (picture hue) adjustment mode. Each time you press the button, the adjustment modes change.

CHROMA ⇄ **PHASE**

To adjust the value, move the MENU control to ◀/▶.

NOTES:

- CHROMA is not adjustable when the B/W (50 Hz/60 Hz) signal is input.
- PHASE is not adjustable when the PAL signal or the B/W (50 Hz/60 Hz) signal is input.

3 CONTRAST (🔴)/BRIGHT (☀️) button

Activates the picture contrast adjustment mode or picture brightness adjustment mode. Each time you press the button, the adjustment modes change.

CONTRAST ⇄ **BRIGHTNESS**

To adjust the value, move the MENU control to ◀/▶.

4 MENU control

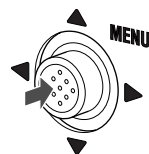

Displays or closes a menu screen.

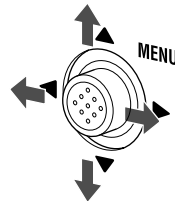

While a menu screen is displayed, selects or adjusts the menu items by moving the control to ▲/▼/◀/▶.

To display the SET-UP MENU:

Press the CHROMA/PHASE button while keeping to move the MENU control to ▼.

To select the channel of the audio output from the audio output terminal on the Multi-Format SDI Unit (option):

NOTE:

This function is valid when using the Multi-Format SDI Unit (option).

When HD/SD SDI signal including EMBEDDED AUDIO signal is input, you can select the channel of the audio signal output from the audio output terminal.

Move the MENU control to ◀/▶ to select the audio output mode while no menu screen is displayed.

- If you change the audio output mode, the channel of the audio signal output from the audio output terminal changes. Refer also to the Multi-Format SDI Unit’s manual.
- Set the group of the audio output modes you want to select beforehand.
- ☞ “E. AUDIO GROUP” on page 15

5 SCAN SIZE button

Reduces the screen size (under-scan) so that the whole screen is displayed.

6 SCREENS CHECK button

Each time you press this button, the screen changes in the following order:

Normal screen → Monochrome screen →
Red screen → Green screen → Blue screen →
(back to the beginning)

7 MARKER button

Turns the MARKER function ON/OFF.

- MARKER function includes MARKER SELECT, ZOOM, ASPECT SELECT, and SAFETY MARKER functions.
☞ "MARKER" on page 12

NOTES:

- Functions do not operate when they are set to OFF in the "MARKER" menu.
- Initial setting of each function in the "MARKER" menu is OFF. Before you use the MARKER function, you must change the "MARKER" menu settings first.
- The ZOOM function does not operate in the under-scan mode.
- When the ZOOM function is operated, the MARKER SELECT and the SAFETY MARKER function in the "MARKER" menu do not work.

8 INPUT SELECT buttons/lamps

Select an input to display.

- A:** Select the video signal input to the VIDEO A terminal.
- B:** Select the video signal input to the VIDEO B terminal.
- C/D:** Select the signal input to the input unit (option) which is attached to the rear panel.
- For details about how to select the input signal through the input unit, refer to the input unit's manual.
- The corresponding lamp of the input currently selected lights up.

9 Power lamp

- Unlit:** The main power is off.
- Orange:** The main power is on and the monitor is in stand-by mode.
- Green:** The monitor is on.

10 Stand-by button

Turns on and off the monitor when the main power is on.

NOTES:

- You cannot turn on the monitor if the main power switch on the rear panel is not turned on.
- You can set the delay time between when the stand-by button is pressed and when the monitor actually turns on.
☞ "RUSH DELAY TIME" on page 15

■ About the status display

Displays information of the current input selection and the monitor settings for about 3 seconds.

To show the status display, set "STATUS DISPLAY" to "AUTO" or "MANUAL" beforehand.

☞ "STATUS DISPLAY" on page 18

Pressing the INPUT SELECT button currently selected shows the status display.

NOTE:

When "STATUS DISPLAY" is set to "AUTO," the status display also appears on the screen if you change the inputs or the signal condition changes.

VIDEO	①
NTSC	②
HIGH	③
EXT. SYNC	④
OVER	⑤
COLOR	⑥
MARKER ON	⑦

① Input status

② Signal format

- "NO SYNC" is displayed when no video signal is input or no synchronized signal is detected.
- If "NO SYNC" is displayed even though a video signal is input, check the setting of "SYNC SELECT."
☞ "SYNC SELECT" on page 15
- "Out of range" is displayed when a noncompliant signal is input.

③ Setting of "COLOR TEMP."

- ☞ "COLOR TEMP." on page 16
- " * " is displayed if white balance is adjusted in the "COLOR TEMP./BAL." menu.

④ Appears when "SYNC SELECT" is set to "EXT." (External synchronization)

- ☞ "SYNC SELECT" on page 15

⑤ Setting of SCAN SIZE

- ☞ "[5] SCAN SIZE button" on the left column
- OVER: Over-scan
UNDER: Under-scan

⑥ Setting of SCREENS CHECK

- ☞ "[6] SCREENS CHECK button" on the left column
- COLOR: Normal screen
MONO: Monochrome screen
R ONLY: Red screen
G ONLY: Green screen
B ONLY: Blue screen

⑦ Setting of MARKER

- ☞ "[7] MARKER button" on the left column

Controls and Features (cont.)

Rear Panel

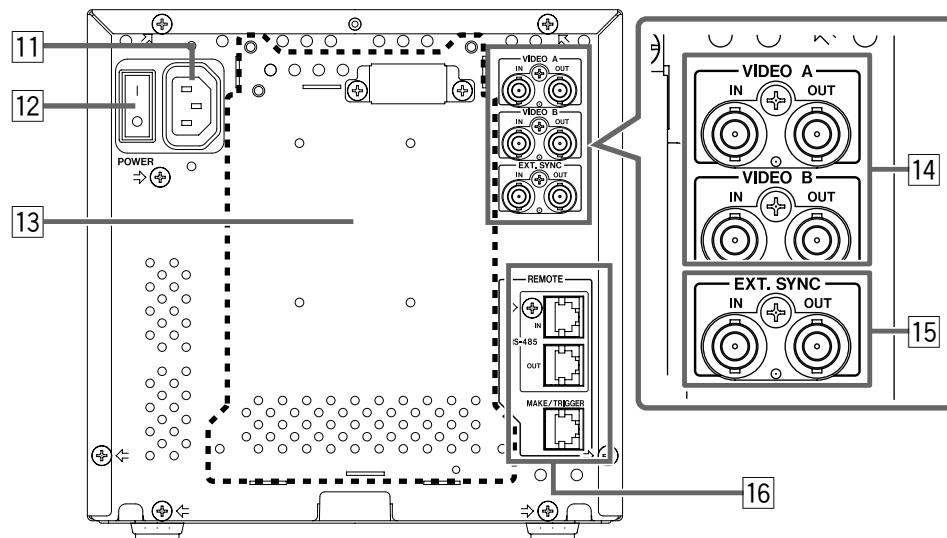

11 AC inlet

Power input connector. Connect the provided AC power cord to an AC outlet (120 V/220-240 V AC, 50 Hz/60 Hz).

* Attach the provided Power Cord Holder to prevent accidental disconnection of the AC power cord.

☞ Page 8

12 Main power switch

Turns on and off the main power.

• I : on O : off

NOTE:

You need to turn on the stand-by button on the front panel to turn on the monitor after turning on the main power switch.

13 Input unit area

You can attach the input unit (option) to this area of the rear panel.

Attaching the input unit expands the monitor's input capacity.

- Consult your dealer about the input unit.
- Refer to the input unit's manual about how to attach it.

14 Composite signal input/output terminals (VIDEO A, VIDEO B)

Input (IN) and output (OUT) terminals for the composite signals of the NTSC, PAL, and B/W (50 Hz/60 Hz).

• NTSC and PAL are switched in the "COLOR SYSTEM."

☞ "COLOR SYSTEM" on page 15

To Select VIDEO A terminal: Press the INPUT SELECT A button.

To Select VIDEO B terminal: Press the INPUT SELECT B button.

* The IN and OUT terminals are bridge-connected (auto termination).

15 External synchronized signal input/output terminals (for both VIDEO A and VIDEO B)

Input (IN) and output (OUT) terminals for the complex synchronized signals.

- To use these terminals, set "SYNC SELECT" to "EXT."
☞ "SYNC SELECT" on page 15

NOTES:

- When an external synchronized signal is input, external synchronization is prioritized for both VIDEO A and VIDEO B.
- The IN and OUT terminals are bridge-connected (auto termination).

16 REMOTE (external control) terminals

Terminals for controlling the monitor by an external control.

☞ "How to Use the External Control" on pages 19 and 20

RS-485 IN terminal:

Enables the monitor to be controlled from a personal computer via a serial cable.

RS-485 OUT terminal:

Enables a cascade control connection. Multiple monitors can be controlled by the device connected to the IN terminal.

MAKE/TRIGGER terminal:

Enables the monitor to be controlled by short-circuiting the pin terminal in this terminal or by inputting the pulse signal.

Preparation

Attaching the Wide Mask

A wide mask is provided with the monitor. This changes the viewable screen area to the 16:9 aspect ratio.

Caution:

- The wide mask cannot be attached to the monitor after the monitor is mounted in a rack. Mount the wide mask before installing the monitor in a rack.
- If you attach and remove the wide mask many times, the screws may not be fixed securely.
- Use only the provided screws.

- 1. Prepare the provided wide mask and 4 screws (for attaching).**
- 2. Attach the wide mask to the monitor.**

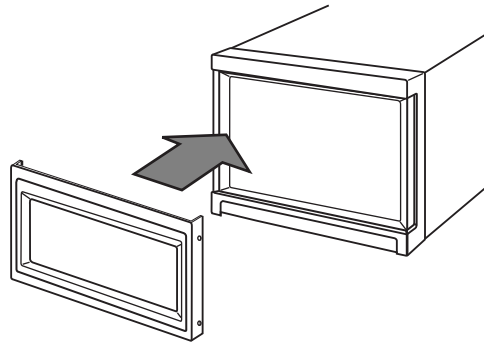

- 3. Secure the wide mask with the screws (fix 2 screws each to both right and left side).**

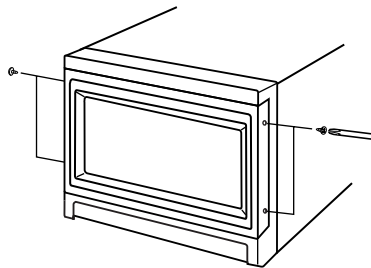

- When detaching the wide mask, follow this procedure in reverse.

Preparation (cont.)

Attaching the Power Cord Holder

- The provided Power Cord Holder prevents accidental disconnection of the AC power cord from the AC inlet.
- The Power Cord Holder consists of two parts; a case and a cover.

1. Attach the Power Cord Holder case to the AC inlet on the back of the monitor with 2 screws (provided).

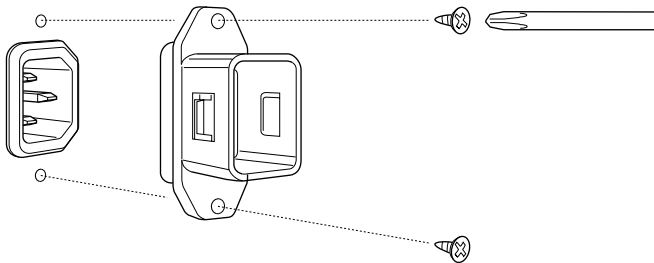

Caution:
Use only the provided screws.

2. Attach the Power Cord Holder cover to the AC power cord.

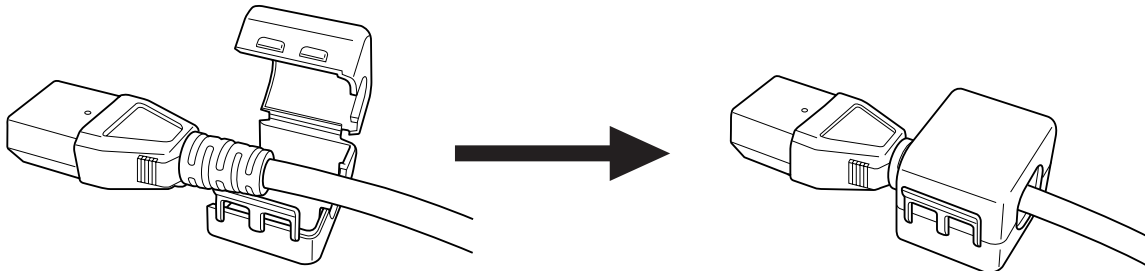

Close the cover until it clicks.

3. Connect the AC power cord to the AC inlet, and join the Power Cord Holder cover with the case.

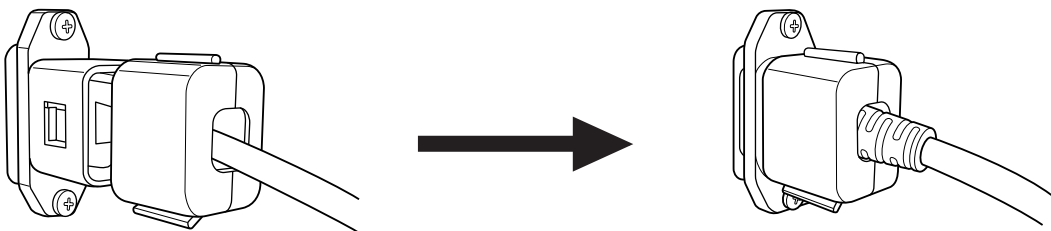

Hold until it clicks.

Caution:

- A different plug shape will result in the cover being attached to a different position.
- Make sure the plug doesn't pull out after the cover is attached.

NOTE:

To disconnect the power cord, click the tab to open the cover.

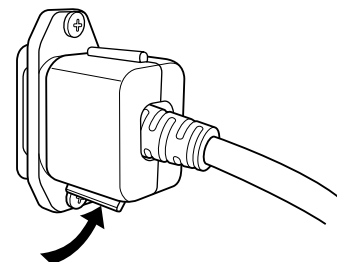

Basic Menu Operations (MAIN MENU, SET-UP MENU)

About the Menu Screens

This monitor features MAIN MENU which contains the functions normally used and SET-UP MENU which contains the initial settings of the monitor.

MAIN MENU

Items	Functions
APERTURE CONTROL	Compensates the frequency characteristics of the input video signal.
sub menu SELECT	Selects the positions and the contents of the sub-menu display.
MARKER	Controls ON/OFF and other settings of the MARKER SELECT, ZOOM, ASPECT SELECT, and SAFETY MARKER functions included in the MARKER function.
COLOR MATRIX	Selects or adjusts the picture color matrix.
ASPECT	Selects the aspect ratio.
DEGAUSS on	Degausses the screen.

SET-UP MENU

Items	Functions
FUNCTION SETTING	Sets the control systems for the COLOR SYSTEM, synchronized signal, RUSH DELAY TIME, colors and functions of the tally lamp, groups of the audio output modes, and MAKE/TRIGGER terminal. * Can be also used to adjust the zooming position of the picture for the component signal input, and check the amount of time that the monitor has been used.
PICTURE SUB ADJ.	The standard value ("00") of the picture adjustment is initially set at the factory. You can adjust the standard value as your initial setting. * Can also be used to switch the NTSC set-up level, and change the component or SD SDI signal's input level settings.
COLOR TEMP./BAL.	Sets or adjusts the color temperature or white balance.
SIZE/POSI. ADJ.	Adjusts the size or position of the picture. * Can also be used to adjust the zoomed picture size.
DISTORTION ADJ.	Compensates the picture distortion, tilt, and the color heterogeneity caused by the geomagnetic influence.
STATUS DISPLAY	Sets the items related to the display screens, such as the status display or the AUDIO LEVEL METER display. * Can also be used to set the 1080/60i or 1035/60i signal displayed correctly.
CONTROL LOCK	Sets the control lock preventing the monitor from misuse.
all reset	Sets all items in SET-UP MENU to factory-preset values.

NOTE:

Some items may not appear on the menu depending on the input (or the input unit if it is attached) or the input signal. Those items are not available to use.

Buttons for Menu Operations

CHROMA/PHASE button
To display SET-UP MENU, press the CHROMA/PHASE button while keeping to move the MENU control to ▽.

MENU control
Displays or closes a menu screen.
While a menu screen is displayed, selects or adjusts the menu items by moving the control to △▽/</>.

Basic Menu Operations

(MAIN MENU, SET-UP MENU) (cont.)

■ Displaying the Menu Screens

To display MAIN MENU

Press the MENU control on the front panel.

To display SET-UP MENU

Press the CHROMA/PHASE button while keeping to move the MENU control to ▽.

NOTES:

- To exit the menu, press the MENU control several times.
- The menu automatically exits about 30 seconds after the last menu operation.
- To go back to the previous menu, press the MENU control.

■ Menu Operation Procedure

1. Press the MENU control.

MAIN MENU is displayed on the screen.

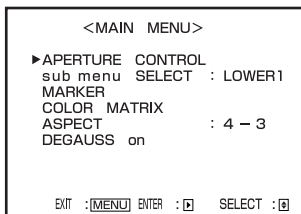

2. Move the MENU control to △ / ▽ to select the item you want to set, then move it to ▷.

The menu screen of the selected item is displayed on the screen.

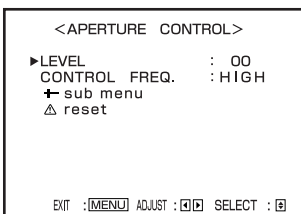

(Ex)

3. Move the MENU control to △ / ▽ to select the item you want to adjust.

4. Move the MENU control to ◀ / ▶ to make adjustments.



(Ex)

5. Press the MENU control several times to delete MAIN MENU.

■ About “+ sub menu”

Only displays selected items. (sub-menu display) Allows you to adjust and set items while looking at the actual screen.

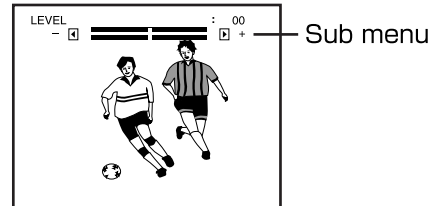

NOTE:

This function is available only when “+ sub menu” is displayed in the menu.

1. Select “+ sub menu,” then move the MENU control to ▷.

The adjustment bar is displayed at the bottom or top of the screen.

2. Move the MENU control to △ / ▽ to select the item you want to set.

3. Move the MENU control to ◀ / ▶ to make adjustments.

To delete the sub-menu display:

Press the MENU control.

To change the positions and the contents of the sub-menu display

Select “sub menu SELECT” in MAIN MENU, then change the setting by moving the MENU control to ◀ / ▶.

UPPER1: The adjustment value and bar appear at the top of the screen.

UPPER2: The adjustment value appears at the top of the screen.

LOWER1: The adjustment value and bar appear at the bottom of the screen.

LOWER2: The adjustment value appears at the bottom of the screen.

■ About “reset”

Restores all menu settings (currently displayed) to factory-preset values.

1. Move the MENU control to △ / ▽ to select “reset,” then move it to ▷. Confirmation message is displayed.

2. To initialize, move the MENU control to ▷.

To cancel the initialization, press the MENU control.

NOTE:

This function is only available when “reset” is displayed in the menu.

How to Use MAIN MENU

MAIN MENU Screens

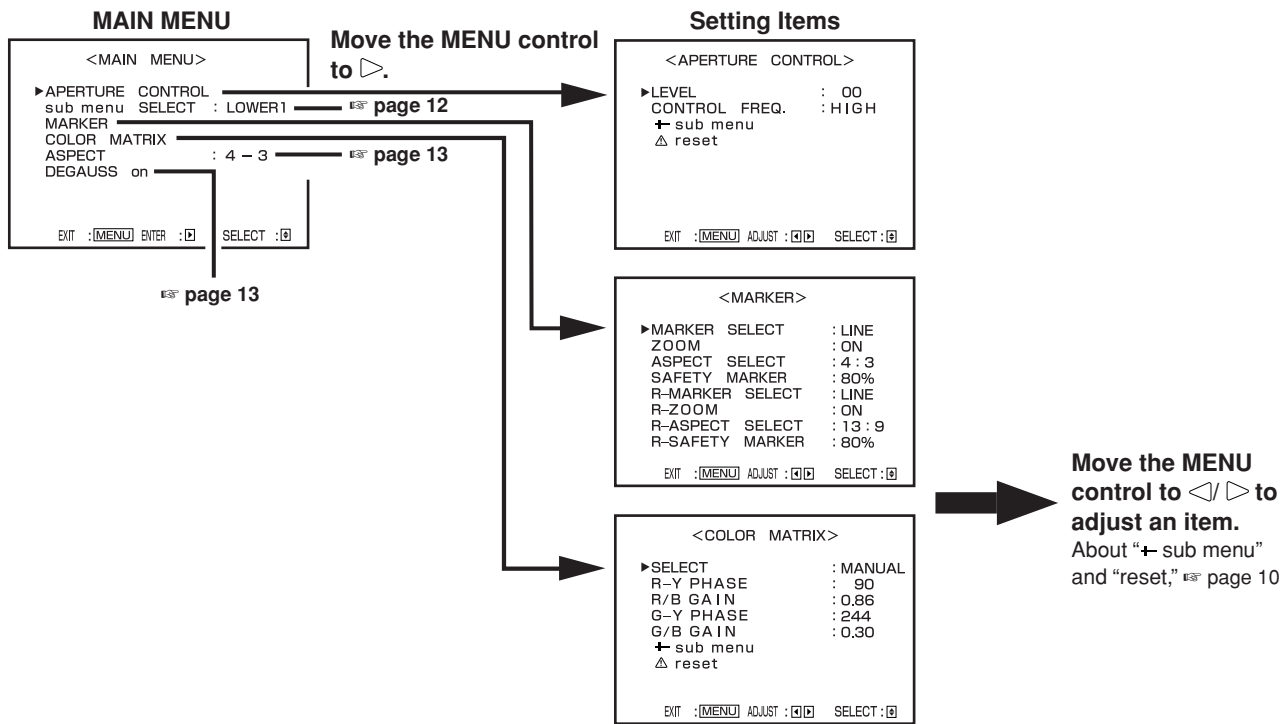

* To go back to the previous menu, press the MENU control.

NOTE:

Some items may not appear on the menu depending on the input (or the input unit if it is attached) or the input signal. Those items are not available to use.

How to Use MAIN MENU (cont.)

Functions, Contents, and Adjustment Range of items

APERTURE CONTROL

<APERTURE CONTROL>	
▶LEVEL	: 00
CONTROL FREQ.	: HIGH
← sub menu	
Δ reset	
EXIT : [MENU] ADJUST : [] SELECT : []	

Compensates the frequency characteristics of the input video signal.

■ LEVEL

Adjusts the compensate value. The higher the number is, the larger the compensate value gets.

• 00 ⇄ 10

■ CONTROL FREQ.

Selects the frequency to compensate.

HIGH: Compensates the high frequencies.

LOW: Compensates the low frequencies.

OFF: Deactivates the aperture compensation.

sub menu SELECT

Selects the positions and the contents of the sub-menu display.

☞ "To change the positions and the contents of the sub-menu display" on page 10

MARKER

<MARKER>	
▶MARKER SELECT	: LINE
ZOOM	: ON
ASPECT SELECT	: 4 : 3
SAFETY MARKER	: 80%
R-MARKER SELECT	: LINE
R-ZOOM	: ON
R-ASPECT SELECT	: 13 : 9
R-SAFETY MARKER	: 80%
EXIT : [MENU] ADJUST : [] SELECT : []	

Controls ON/OFF and other settings of the MARKER SELECT, ZOOM, ASPECT SELECT, and SAFETY MARKER functions included in the MARKER function.

NOTES:

- For the 4:3 screen ratio, only SAFETY MARKER and R-SAFETY MARKER are displayed.
- To set up non-"R-" items, press the MARKER button on the front panel. An external control system should not be operated at this time.
- Using the external control, you can select either "R-" items or non-"R-" items to activate.
☞ "How to Use the External Control" on pages 19 and 20

■ MARKER SELECT/R-MARKER SELECT

It displays the area of the aspect ratio that has been set in the ASPECT SELECT/R-ASPECT SELECT, superimposed on the current screen.

OFF: MARKER SELECT does not function.

LINE: Displays the area with an outline.

HALF: The area outside the specified screen ratio is displayed as a 50% transparency.

HALF+L: The area of the specified screen ratio is indicated by an outline, and the area outside of that is displayed as a 50% transparency.

BLK.: The area outside the specified screen ratio is black. Only the portion of the picture within the designated area is displayed.

BLK. +L: The area of the specified screen ratio is indicated by an outline, and the area outside of that becomes black so that only the area inside the line is displayed.

NOTE:

Does not function when the ZOOM function is operated.

■ ZOOM/R-ZOOM

Zooms the area of 4:3 aspect ratio to fill the whole screen when the signal of 16:9 format is input.

This item appears on the menu only when using the Multi-Format SDI Unit (option) or the Component Unit (option).

OFF: Does not zoom.

ON: Zooms.

NOTES:

- Does not function when under-scan is operated.
- To adjust the zoomed picture size, ☞ "ZOOM H. SIZE" and "ZOOM V. SIZE" on page 17.
- When zooming the picture for the component signal input, you can adjust the horizontal position of the zooming area.
☞ "ZOOM WINDOW" on page 15

■ ASPECT SELECT/R-ASPECT SELECT

Selects the aspect ratio.

- 4:3/13:9/14:9

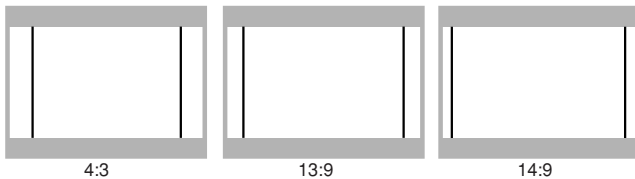

■ SAFETY MARKER/R-SAFETY MARKER

Displays dotted lines to indicate the areas corresponding to 80%, 88%, or 90% of the screen size (the aspect ratio setting in "ASPECT SELECT/R-ASPECT SELECT").

- OFF:** SAFETY MARKER does not function.
- 80%:** Marked area is 80% of the screen.
- 88%:** Marked area is 88% of the screen.
- 90%:** Marked area is 90% of the screen.

NOTES:

- Does not function when the ZOOM function is operated.
- When a picture of 4:3 aspect ratio is input, SAFETY MARKER for 4:3 screen is displayed.
- To display SAFETY MARKER for 16:9 screen ratio when a picture of 16:9 aspect ratio is input, set "MARKER SELECT/R-MARKER SELECT" to OFF. (In this case, setting of ASPECT SELECT is invalid.)

COLOR MATRIX

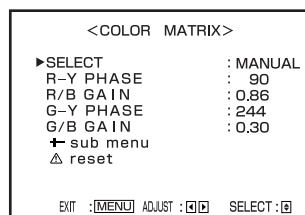

Selects or adjusts the standard of the color demodulation (color rendering).

The menu screen when MANUAL is selected.

- The standard setting is set to "ITU601" or "ITU709" depending on the input signal format. The factory preset of MANUAL is ITU709.

Input Signal Format	Standard setting	Manual setting (MANUAL)
NTSC, PAL, B/W (50 Hz/60 Hz), 480/60i, 576/50i	ITU601	ITU709
720/60p, 720/50p, 1080/50i, 1080/60i, 1035/60i, 1080/24psF	ITU709	

■ SELECT

Selects the picture matrix standard.

- ITU601 or ITU709:** Standard setting
- MANUAL:** Manual setting

NOTE:

The following items are displayed when MANUAL is selected. When ITU601 or ITU709 is selected, they are not displayed.

■ R-Y PHASE

Sets the R-Y phase.

- 90/92/94/112

■ R/B GAIN

Sets the R/B gain.

- 0.56/0.68/0.79/0.86

■ G-Y PHASE

Sets the G-Y phase.

- 236/240/244/253

■ G/B GAIN

Sets the G/B gain.

- 0.30/0.34/0.40/0.45

NOTE:

Adjustment value of each item in the standard setting (ITU601/ITU709) is as follows:

ITU601	R-Y PHASE	90
	R/B GAIN	0.79
	G-Y PHASE	244
	G/B GAIN	0.45
ITU709	R-Y PHASE	90
	R/B GAIN	0.86
	G-Y PHASE	244
	G/B GAIN	0.30

ASPECT

Selects the aspect ratio.

- 4:3/16:9

DEGAUSS on

Degausses the screen.

While degaussing, "Degaussing!" is displayed on the screen.

How to Use SET-UP MENU

SET-UP MENU Screens

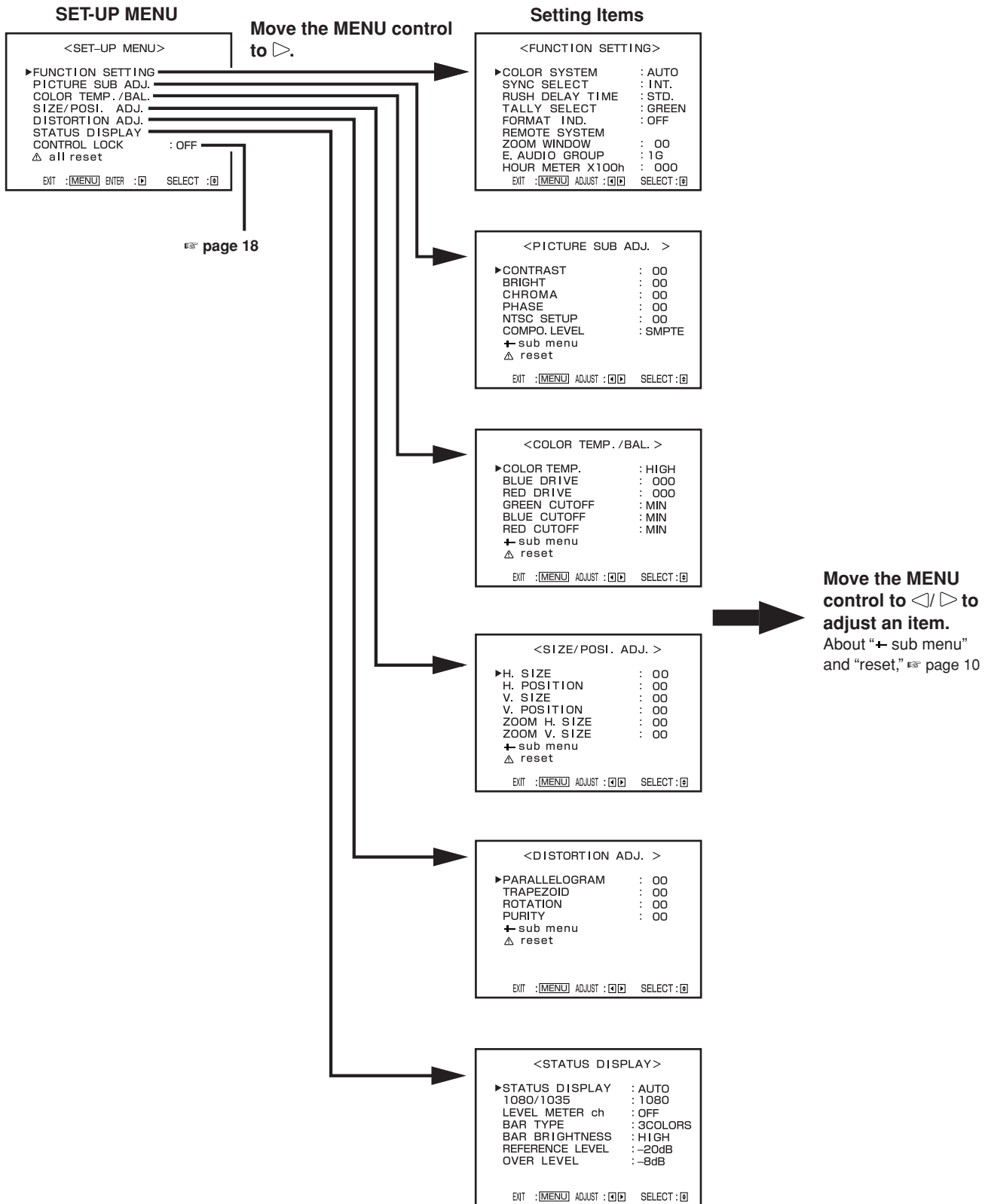

* To go back to the previous menu, press the MENU control.

NOTE:

Some items may not appear on the menu depending on the input (or the input unit if it is attached) or the input signal. Those items are not available to use.

Functions, Contents, and Adjustment Range of items

FUNCTION SETTING

<FUNCTION SETTING>	
▶COLOR SYSTEM	: AUTO
SYNC SELECT	: INT.
RUSH DELAY TIME	: STD.
TALLY SELECT	: GREEN
FORMAT IND.	: OFF
REMOTE SYSTEM	
ZOOM WINDOW	: 00
E. AUDIO GROUP	: 1G
HOUR METER X100h	: 000
EXIT : [MENU] ADJUST : [OK] SELECT : [ENTER]	

Sets the control systems for the COLOR SYSTEM, synchronized signal, RUSH DELAY TIME, colors and functions of the tally lamp, groups of the audio output modes, and MAKE/TRIGGER terminal.

- Can be also used to adjust the zooming position of the picture for the component signal input, and check the amount of time that the monitor has been used.

■ COLOR SYSTEM

Selects the color system.

AUTO: Changes NTSC and PAL automatically.

NTSC: Keeps the color system NTSC.

PAL: Keeps the color system PAL.

NOTE:

Normally select AUTO. However, if the input signal is unstable, select NTSC or PAL.

■ SYNC SELECT

Selects the synchronized signal.

INT.: The input video signal is synchronized with the built-in sync signal.

EXT.: The input video signal is synchronized with an external signal from an external sync terminal.

■ RUSH DELAY TIME

Sets the delay time between when the stand-by button is pressed and when the monitor actually turns on.

STD.: Power turns on about 1 second after the stand-by button is pressed.

SLOW: Power turns on about 3.2 seconds after the stand-by button is pressed.

NOTE:

It is recommended to apply "SLOW" to some of the monitors if you need to turn on multiple monitors at the same time. You can control the rush current of the entire system.

■ TALLY SELECT

Selects the color of the tally lamp on the upper right of the front panel.

GREEN: The tally lamp lights in green.

RED: The tally lamp lights in red.

NOTES:

- "TALLY SELECT" does not appear on the menu when both the following conditions are applied:
 - When selecting "TA. SEL" to a pin terminal of the MAKE/TRIGGER terminal in "REMOTE SYSTEM" of SET-UP MENU.
 - When activating the external control.
- The tally lamp is controlled using the MAKE/TRIGGER terminal of the REMOTE (external control) terminals.

☞ page 19

■ FORMAT IND.

Sets the tally lamp as the format indicator to show the format of the signal currently input.

NOTE:

When setting FORMAT IND. to ON, you cannot use the tally lamp function of the MAKE/TRIGGER terminals.

☞ page 19

ON: Uses the lamp as the format indicator.

Green: Shows the HD SDI signal is input.

Red: Shows the SD SDI signal is input.

Orange: Shows the composite signal is input.

OFF: Uses the lamp as the tally lamp.

☞ page 19

■ REMOTE SYSTEM

Sets the MAKE/TRIGGER terminal.

☞ "How to Use the MAKE/TRIGGER Terminal" on page 19

CONTROL FORM:

Selects the control system for the MAKE/TRIGGER terminal.

MAKE: Selects the make contact system as the external control method.

TRIG.: Selects the trigger system as the external control method.

SET: You can apply the functions to the 1st to 6th pin terminals of the MAKE/TRIGGER terminal as you want.

PORT F1 – PORT F6:

Selects the function to be applied to the 1st to 6th pin terminals of the MAKE/TRIGGER terminal.

☞ "How to Use the MAKE/TRIGGER Terminal" on page 19

NOTE:

You can set "PORT F1" – "PORT F6" only when "CONTROL FORM" is set to "SET."

■ ZOOM WINDOW

Adjusts the horizontal position of the zooming area. This item appears on the menu only when using the Component Unit (option).

• **-30 00 +30**

–: Moves the horizontal position of the zooming area to the left.

+ : Moves the horizontal position of the zooming area to the right.

■ E. AUDIO GROUP

Sets the group of the available audio output modes selected by the MENU control.

This item appears on the menu only when using the Multi-Format SDI Unit (option).

1G: 1ch ↔ 2ch ↔ 3ch ↔ 4ch ↔ 1-2ch ↔ 3-4ch ↔ 1-4ch

2G: 5ch ↔ 6ch ↔ 7ch ↔ 8ch ↔ 5-6ch ↔ 7-8ch ↔ 5-8ch

1-2G: 1ch ↔ 2ch ↔ 3ch ↔ 4ch ↔ 5ch ↔ 6ch ↔ 7ch ↔ 8ch ↔ 1-2ch
 ↓
 AUTO ↔ 5-8ch ↔ 1-4ch ↔ 7-8ch ↔ 5-6ch ↔ 3-4ch

- When HD/SD SDI signal including EMBEDDED AUDIO signal is input, you can select the channel of the audio signal output from the audio output terminal by changing the audio output mode. Refer also to the Multi-Format SDI unit's manual.

How to Use SET-UP MENU (cont.)

■ HOUR METER X100h

Displays the total usage time of the monitor in hundred-hour units.

• 000 ⇄ 655

NOTES:

- When the timer passes 655, it returns to 000.
- The timer does not count the usage time under one hour.

PICTURE SUB ADJ.

<PICTURE SUB ADJ. >	
▶CONTRAST	: 00
BRIGHT	: 00
CHROMA	: 00
PHASE	: 00
NTSC SETUP	: 00
COMPO. LEVEL	: SMPTE
← sub menu	
△ reset	
EXIT : [MENU] ADJUST : [] [] SELECT : []	

The standard value ("00") of the picture adjustment is initially set at the factory.

You can adjust the standard value as your initial setting.

- Can also be used to switch the NTSC set-up level, and change the component or SD SDI signal's input level settings.

■ CONTRAST

• -20 ⇄ 00 ⇄ +20

■ BRIGHT

• -20 ⇄ 00 ⇄ +20

■ CHROMA

• -20 ⇄ 00 ⇄ +20

■ PHASE

• -20 ⇄ 00 ⇄ +20

■ NTSC SETUP

Sets the set-up level of the input NTSC signal.

00: Compliant with 0% set-up signal.

7.5: Compliant with 7.5% set-up signal.

■ COMPO. LEVEL

Sets the set-up level of the input component or SD SDI signal.

This item appears on the menu only when using the Multi-Format SDI Unit (option) or the Component Unit (option).

SMPTE: Compliant with M2VTR signals.

B00: Compliant with Betacam 0% set-up signal.

B75: Compliant with Betacam 7.5% set-up signal.

COLOR TEMP./BAL.

<COLOR TEMP./BAL. >	
▶COLOR TEMP.	: HIGH
BLUE DRIVE	: 000
RED DRIVE	: 000
GREEN CUTOFF	: MIN ※
BLUE CUTOFF	: MIN
RED CUTOFF	: MIN
← sub menu	
△ reset	
EXIT : [MENU] ADJUST : [] [] SELECT : []	

Sets or adjusts the color temperature or white balance.

NOTE:

Use the five items indicated with ※ mark to make fine adjustments between the monitors.

■ COLOR TEMP.

Selects the color temperature.

HIGH: Sets the color temperature to 9300.

LOW: Sets the color temperature to 6500.

■ BLUE DRIVE

Adjusts the blue drive level.

• **MIN** ⇄ 000 ⇄ **MAX** (in 127 grades)

■ RED DRIVE

Adjusts the red drive level.

• **MIN** ⇄ 000 ⇄ **MAX** (in 127 grades)

■ GREEN CUTOFF

Adjusts the green cut-off point.

• **MIN** ⇄ **MAX** (in 155 grades)

■ BLUE CUTOFF

Adjusts the blue cut-off point.

• **MIN** ⇄ **MAX** (in 155 grades)

■ RED CUTOFF

Adjusts the red cut-off point.

• **MIN** ⇄ **MAX** (in 155 grades)

SIZE/POSI. ADJ.

<SIZE/POSI. ADJ. >	
▶H. SIZE	: 00
H. POSITION	: 00
V. SIZE	: 00
V. POSITION	: 00
ZOOM H. SIZE	: 00
ZOOM V. SIZE	: 00
← sub menu	
△ reset	
EXIT : [MENU] ADJUST : [OK] SELECT : [OK]	

Adjusts the size or position of the picture.

- Can also be used to adjust the zoomed picture size.

■ H. SIZE

Adjusts the horizontal screen size.

- **-20** $\bar{\bar{}}$ **00** $\bar{\bar{}}$ **+20** (*)

-: Reduces the screen size horizontally.

+: Enlarges the screen size horizontally.

* You can adjust this item with in the range between 00 and +20 during the under-scan mode.

■ H. POSITION

Adjusts the horizontal screen position.

- **-20** $\bar{\bar{}}$ **00** $\bar{\bar{}}$ **+20**

-: Moves the screen to the left.

+: Moves the screen to the right.

■ V. SIZE

Adjusts the vertical screen size.

- **-20** $\bar{\bar{}}$ **00** $\bar{\bar{}}$ **+20**

-: Reduces the screen size vertically.

+: Enlarges the screen size vertically.

■ V. POSITION

Adjusts the vertical screen position.

- **-10** $\bar{\bar{}}$ **00** $\bar{\bar{}}$ **+10**

-: Moves the screen down.

+: Moves the screen up.

■ ZOOM H. SIZE

- **- 20** $\bar{\bar{}}$ **00**

■ ZOOM V. SIZE

- **-20** $\bar{\bar{}}$ **00** $\bar{\bar{}}$ **+20**

NOTE:

ZOOM H. SIZE and ZOOM V. SIZE are displayed only when the ZOOM function is operated. ZOOM H. SIZE adjusts the screen size horizontally, and ZOOM V. SIZE adjusts it vertically when the ZOOM is operated.

DISTORTION ADJ.

<DISTORTION ADJ. >	
▶PARALLELOGRAM	: 00
TRAPEZOID	: 00
ROTATION	: 00
PURITY	: 00
← sub menu	
△ reset	
EXIT : [MENU] ADJUST : [OK] SELECT : [OK]	

Compensates the picture distortion, tilt, and the color heterogeneity caused by the geomagnetic influence.

■ PARALLELOGRAM

Compensates the parallelogram picture distortion.

- **-20** $\bar{\bar{}}$ **00** $\bar{\bar{}}$ **+20**

-: Moves the upper side of the picture to the right, and the lower side to the left.

+: Moves the upper side of the picture to the left, and the lower side to the right.

■ TRAPEZOID

Compensates the trapezoid picture distortion.

- **-20** $\bar{\bar{}}$ **00** $\bar{\bar{}}$ **+20**

-: Enlarges the upper side of the picture.

+: Reduces the upper side of the picture.

■ ROTATION

Compensates a picture tilt.

- **-31** $\bar{\bar{}}$ **00** $\bar{\bar{}}$ **+31**

-: Turns the picture clockwise.

+: Turns the picture counterclockwise.

■ PURITY

According to the location of the monitor, there may be the color heterogeneity around the rim of the screen caused by the geomagnetic influence.

You can avoid this color heterogeneity with this function decreasing the geomagnetic influence.

- **-31** $\bar{\bar{}}$ **00** $\bar{\bar{}}$ **+31**

How to Use SET-UP MENU (cont.)

STATUS DISPLAY

<STATUS DISPLAY>	
▶STATUS DISPLAY	: AUTO
1080/1035	: 1080
LEVEL METER ch	: OFF
BAR TYPE	: 3COLORS
BAR BRIGHTNESS	: HIGH
REFERENCE LEVEL	: -20dB
OVER LEVEL	: -8dB
EXIT : [MENU] ADJUST : [OK] SELECT : [▶]	

Sets the items related to the display screens, such as the status display or the AUDIO LEVEL METER display.

- Can also be used to set the 1080/60i or 1035/60i signal displayed correctly.

■ STATUS DISPLAY

Sets the status display.

- **AUTO/MANUAL/OFF**

☞ “About the status display” on page 5

■ 1080/1035

When the component signal is input, the monitor does not automatically discriminate the 1080/60i signal from the 1035/60i signal. Set this item according to the input signal format.

This item appears on the menu only when using the Component Unit (option).

- **1080/1035**

Setting the AUDIO LEVEL METER display

You can check the conditions of the current EMBEDDED AUDIO signals on the AUDIO LEVEL METER display.

AUDIO LEVEL METER display example
LEVEL METER ch: 1-8, BAR TYPE: 3COLORS

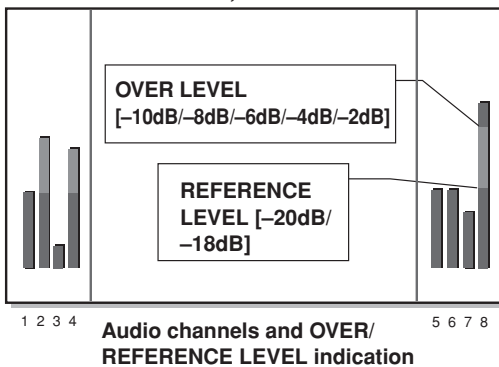

The following items are the settings for the AUDIO LEVEL METER display.

The following items appear on the menu only when using the Multi-Format SDI Unit (option).

■ LEVEL METER ch

Selects the audio channels used in the AUDIO LEVEL METER display.

- **OFF/1:2/12:34/31:24/123:456/1-8**

NOTES:

- This item does not appear on the menu when both the following conditions are applied:
 - When selecting “L. METER” to a pin terminal of the MAKE/TRIGGER terminal and “MAKE” to “CONTROL FORM” of “REMOTE SYSTEM” in SET-UP MENU.
 - When activating the external control.
- ☞ “REMOTE SYSTEM” on page 15 and page 19
- Numbers indicate the audio channel. The channel input level indicated on the left side of “:” is displayed on the left side of the screen, and the channel input level indicated on the right side of “:” is displayed on the right side of the screen.
- The AUDIO LEVEL METER display does not appear when this item is set to OFF.

- When “1-8” is selected, the channel input level for 1, 2, 3 and 4 is displayed on the left side of the screen, and the channel input level for 5, 6, 7 and 8 is displayed on the right side of the screen.
- The AUDIO LEVEL METER display moves to inside of the screen when the ZOOM function is operated.

■ BAR TYPE

Selects the color of the AUDIO LEVEL METER display.

W. 100: White color display

W. 50: White (half transparent) display

3COLORS:

The AUDIO LEVEL METER display uses three different colors (red, yellow and green) to indicate variations in input levels.

Red: Displayed when the audio input is at the same level set in “OVER LEVEL” or higher.

Yellow: Displayed when the audio input is at the same level set in “REFERENCE LEVEL” or higher.

Green: Displayed when the audio input is lower than the level set in “REFERENCE LEVEL.”

NOTES:

- For W. 100 and W. 50, the line indication for the standard input level set in the “REFERENCE LEVEL” is displayed. Input level set in the “OVER LEVEL” is not displayed.
- As for the audio channel bar display with no signal input, white is displayed for the 3COLORS setting, and gray is displayed for other settings.

■ BAR BRIGHTNESS

Selects the brightness of the AUDIO LEVEL METER display.

HIGH: Brighter

LOW: Darker

■ REFERENCE LEVEL

Sets the standard input level.

- **-20dB/-18dB**

■ OVER LEVEL

Sets the input level’s lower limit indicated in red for the “3COLORS” display.

- **-10dB/-8dB/-6dB/-4dB/-2dB**

CONTROL LOCK

■ CONTROL LOCK

Prohibits the monitor operations except turning on/off the monitor and deactivating this function.

- Operating the monitor by the external control is available if this function is activated.

ON: Activates this function.





OFF: Deactivates this function.

NOTE:

- When “CONTROL LOCK” is set to “ON,”  Control lock on! appears on the screen if you try to operate the monitor.

all reset

Resets all SET-UP MENU items to factory-preset values.

1. Move the MENU control to  /  to select “all reset,” then move it to . Confirmation message is displayed.
 2. To initialize, move the MENU control to .
- To cancel the initialization, press the MENU control.

How to Use the External Control

About the External Control

The Multi-Format Monitor has two external control terminals.

One is the MAKE/TRIGGER terminal, which allows the monitor to be controlled by the MAKE (make contact) or TRIG. (trigger) method selected in the function setting.

MAKE (make contact system): Controls the function by short-circuiting the corresponding pin terminal to the GND pin terminal, or disconnecting (opening) it.

TRIG. (trigger system): Controls the function by inputting the pulse signal instantaneously to the corresponding pin terminal.
* MAKE or TRIG. are selected from "REMOTE SYSTEM" in SET-UP MENU.

The other terminal used for remote control is the RS-485 terminal, and this allows the monitor to be controlled by serial communication.

NOTE:

Control priority is in the following order; ① MAKE/TRIGGER terminal > ② RS-485 terminal > ③ Front panel buttons or menu functions of the monitor.

• When using the make contact system, you cannot use the functions which are applied to the MAKE/TRIGGER terminal operating the front panel buttons or the menu of the monitor. (When using the trigger system you can also use those functions operating the monitor directly.)

• When controlling the monitor using RS-485 terminal, you cannot use the functions operating the front panel buttons or the menu of the monitor except turning on or off the monitor.

How to Use the MAKE/TRIGGER Terminal

Function of the MAKE/TRIGGER terminal

The followings are the configurations and the functions of the pin terminals of RJ-45 connector. You can change the functions applied to the 1st to 6th pin terminals by setting "REMOTE SYSTEM" of SET-UP MENU.

NO.	Functions to be controlled
1	INP. A Changes the input to INPUT A
2	INP. C Changes the input to INPUT C
3	MARKER Turns on/off MARKER
4	ASPECT Changes ASPECT
5	TALLY Controls the tally lamp
6	L. METER Turns on/off AUDIO LEVEL METER
7	External control
8	GND

Caution:
This is a female connector.

To change the functions applied to the pin terminals

1. Display SET-UP MENU, then move the MENU control to Δ / ∇ to select "REMOTE SYSTEM," then move it to \triangleright .
2. Move the MENU control to Δ / ∇ to select "CONTROL FORM," then move it to $\triangleleft / \triangleright$ to select "SET."
3. Move the MENU control to Δ / ∇ to select the number of the pin terminal (PORT F1 – PORT F6) you want to set, then move it to $\triangleleft / \triangleright$ to select the function.

NOTE:

You cannot apply two or more functions to one terminal.

Functions controlled by the MAKE/TRIGGER Terminal

Display	Functions to be controlled	Opening	Short-circuiting	*1
INP. A	Changes the input to INPUT A	Invalid	Valid	
INP. B	Changes the input to INPUT B	Invalid	Valid	
INP. C	Changes the input to INPUT C	Invalid	Valid	
INP. D	Changes the input to INPUT D	Invalid	Valid	
CO. OFF	Turns on/off COLOR OFF	Off	On (Monochrome screen)	*2
MARKER	Turns on/off MARKER	Off	On	*2
ASPECT	Changes ASPECT	4:3	16:9	
MA. SEL	Selects the MARKER settings	Selects the settings without "R-"	Selects the settings with "R-"	*3
TALLY	Controls the tally lamp	Off	On	*4, 5
TA. SEL	Selects the color of the tally lamp	Green	Red	
STATUS	Turns on/off the status display	Off	On	
L. METER	Turns on/off AUDIO LEVEL METER	Off	On	*6

*1 : The TRIG. (trigger) system switches each function by short-circuiting for approx. 1 second.

*2 : When selecting the TRIG. (trigger) system, these functions cannot be controlled if no signal is input.

*3 : Activates the settings of the items with "R-" or without "R-" in the "MARKER" menu. \Rightarrow "MARKER" on page 12

*4 : This function do not work if you set "FORMAT IND." in "FUNCTION SETTING" of SET-UP MENU to "ON."

*5 : Tally lamp Control and External control (the 7th pin terminal) can be controlled by the MAKE (make contact) system even when you select the "TRIG." (trigger) system.

*6 : This function works only when using the Multi-Format SDI Unit (option).

Operation

1. Short-circuit the 7th pin terminal (External control) to the 8th pin terminal (GND) so that the monitor can be controlled by the external control.
2. **When selecting the "MAKE" (make contact) system**, operate each function by short-circuiting the corresponding pin terminal to the 8th pin terminal (GND) or opening it.
When selecting the "TRIG." (trigger) system, operate each function by Pulse control, that is short-circuiting the corresponding pin terminal to the 8th pin terminal (GND) for about 1 second.

NOTES:

• When controlling INP. A/B/C/D, only one terminal must be short-circuited. (Other terminals must be opened.)

• When selecting the "TRIG." (trigger) system, you can operate only one function at a time. Operate the functions one by one.

How to Use the External Control (cont.)

How to Use the RS-485 Terminal

You can control the monitor from your PC via the RS-485 terminal. For details on operating the monitor from the PC, consult the service center.

1. Cable

Prepare a straight cable with a RJ-45 connector.

2. Communications Specifications

Baud Rate: 4800/9600/19200 (factory pre-set; 4800)
 Data Bits: 8 bits
 Parity: No parity
 Stop Bits: 1 bit
 Communication Cord: ASCII Cord

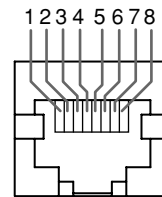

3. Commands

Format

Header	ID	Command ID	Command Content	Data	CR
--------	----	------------	-----------------	------	----

Header

- ! Control from the PC to the monitor
- ? Reference from the PC to the monitor
- @ Answer from the monitor to the PC

Pin No.	IN terminal signal	OUT terminal signal
1	TXD+	TXD+
2	TXD-	TXD-
3	RXD+	RXD+
4	NC	NC
5	NC	NC
6	RXD-	RXD-
7	5 V Power	NC
8	GND	NC

* The 5V power supply of the 7th terminal is for the controller exclusively for this monitor. Do not use it for other devices.

ID + Command + Data

B	Basic command	Characters	00, 01 or No data
D	Command for adjusting the picture size	00-0A, 10	U, D (U: UP, D: DOWN)
S	Command for adjusting the picture quality	00-06	U, D (U: UP, D: DOWN)
M	Command for selecting the menu item	00, 01, 03-11	00, 01, 02, 03
F	Command for selecting the menu item	00-0F, 12, 13	00, 01, 02, 03, 04, 05
W	Command for adjusting the white balance	00, 02-06	U, D (U: UP, D: DOWN)
C	Command for inquiring for the monitor's status	00	0-655

Communication Procedures

The following is the communication procedures.

1. Starting the communication

Receives the connection command (!XXBCN1Cr) from the PC → Sends the monitor's status (@XXBOKCr) to the PC

2. Performing the external control

Receives the control command (!XXXXCr) from the PC → Sends the monitor's status (@XXBOKCr) to the PC

* The monitor repeats these receiving and sending if necessary.

3. Terminating the communication

Receives the termination command (!XXBCN0Cr) → Sends the monitor's status (@XXBOKCr) to the PC

* Hand-shake communication is used. This means that after sending a command to the monitor, the PC must receive a status return from the monitor before sending the next command.

* When the monitor is controlled by a PC via RS-485, a conversion adapter (RS-232C ↔ RS-485) is also required.

Troubleshooting

Solutions to common problems related to your monitor are described here. If none of the solutions presented here solve the problem, unplug the monitor and consult a JVC-authorized dealer or service center for assistance.

Problems	Points to be checked	Measures (Remedy)	Reference pages
No power supply	Is the power plug loosened or disconnected?	Firmly insert the power plug.	—
	Is the main power turned off?	Turn the main power on.	6
No picture with the power on	Is the signal cable disconnected?	Connect the signal cable firmly.	6
	Is the power of the connected component on? Is the signal output from the connected component?	Turn on the power of the connected component and set it correctly.	—
	Is the input selected correctly?	Select the correct input with the INPUT SELECT buttons.	5
	Is the input signal adapted to the monitor's or the input unit's specification?	Check if the input signal format is acceptable to the monitor or the input unit.	23
	Are any of the self-check indicators (INPUT SELECT A through D lamps) blinking?	Follow the procedures in "Self-check Indications."	22
Wrong color	Has the picture adjustment been changed?	Set the adjustment of each picture adjustment button to the standard (00) value. Or, perform "reset" in "PICTURE SUB ADJ." to set each item of picture adjustment to the standard value.	4, 16
	Has the WHITE BALANCE setting been changed?	Perform "reset" in "COLOR TEMP./BAL." to set each item to the standard value.	16
	Is the SCREENS CHECK function activated?	Press the SCREENS CHECK button on the front panel repeatedly to return the screen to normal.	5
	Are any cables connected to the Component Unit if it is attached?	Connect each signal cable firmly.	—
	Has the correct signal been input to the Component Unit if it is attached and the correct input been selected on the monitor?	Press the INPUT SELECT C button when the component signal is input.	—
Unnatural picture	Has "CONTRAST" or "BRIGHT" been changed?	Adjust CONTRAST or BRIGHT by using the front panel buttons. Or, adjust "CONTRAST" or "BRIGHT" in "PICTURE SUB ADJ." in SET-UP MENU.	4, 16
Shaking picture	Is the monitor close to a motor, transformer or any other device generating a strong magnetic field? (a fan, fluorescent light, laser printer, another monitor, etc.)	Move the monitor away from the device until the picture stops shaking. Connect the power plug to another AC outlet away from the former one.	—
Irregular color	Is the monitor placed or moved close to a speaker or any other device incorporating a magnet? Has the position of the monitor been changed with the power on?	Move the device away from the monitor. Perform the DEGAUSS on in MAIN MENU to degauss the screen. When degaussing again, wait more than 30 minutes for maximum effect.	13

Troubleshooting (cont.)

Problems	Points to be checked	Measures (Remedy)	Reference pages
Wrong picture position, wrong picture size	Has the picture position, size, distortion, or tilt been changed?	Adjust the picture size (H. SIZE, V. SIZE) or position (H. POSITION, V. POSITION) in "SIZE/ POSI. ADJ." Adjust the picture distortion (PARALLELOGRAM, TRAPEZOID) or tilt (ROTATION) in "DISTORTION ADJ." It may not be possible to expand the picture due to the selected input mode. In this case, adjustment is impossible.	17
	Has the SCAN SIZE button been pressed?	Press the SCAN SIZE button to invalidate the setting.	5
Some items do not appear on the menu	The items which are not available for the current input (input unit) or the current input signal do not appear on the menu.	Change the input or the input signal.	—
Front panel buttons do not function	Has the CONTROL LOCK function been set to "ON"?	Set the CONTROL LOCK function to "OFF."	18
	Has the monitor's setting been changed to enable control by the external control connected to the REMOTE terminal?	Change the setting of the external control so that the monitor can be operated by the buttons on the front panel.	19, 20

The following are not malfunctions:

- About CRT tube reflection (when Zoom mode is used.)
The screen might appear as brownish white. This is due to a reflection of part of the image on the CRT caused by certain signal sources, and it is not a malfunction.
- When a bright still image (such as a white cloth) is displayed for a long period, it may appear to be colored. This is due to the structure of the cathode ray tube and will disappear when another image is displayed.
- You may sometimes experience a mild electric shock when you touch the picture tube. This phenomenon is due to a normal buildup of static electricity on the CRT and is not harmful.
- The monitor emits a strange sound when the room temperature changes suddenly. This is only a problem if an abnormality appears on the screen as well.
- If two or more monitors are placed close each other, their images may shake or be distorted. This phenomenon is due to mutual interference; it is not a malfunction. Move the monitors away from each other until the interference disappears or turn the power off on any monitor that is not being used.

Self-check Indications

When the screen goes blank, and one or more of the INPUT SELECT A through D lamps on the front control panel start blinking...

This monitor has a self-check function, which allows it to detect malfunctions and alert you. This makes troubleshooting easier. Whenever a problem occurs, a combination of "self-check indicators" (INPUT SELECT A through D lamps) will blink and the monitor's power automatically turns off. If this happens, follow the steps below and contact your dealer to resolve the problem.

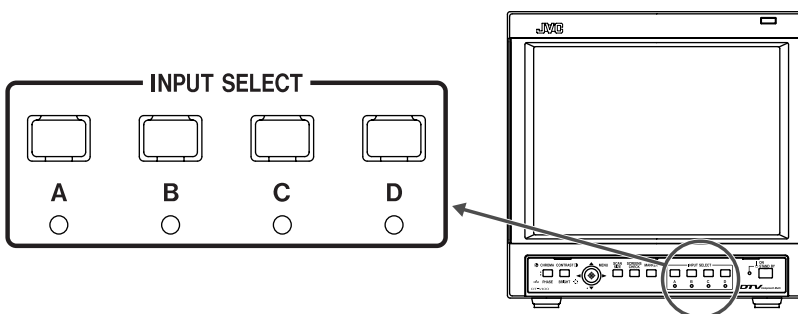

1. Check which indicators are blinking.
2. Turn off the main power switch on the back of the monitor.
3. Disconnect the Power Cord from the AC outlet.
4. Contact your dealer with the information about which indicators are blinking.

NOTE:

If you turn on the monitor's power immediately after turning it off (or after a short-term power failure), the self-check indicators may blink, and no image may be displayed.

When this happens, turn off the power, and wait at least 10 seconds before turning it on again. If the self-check indicators have stopped blinking, you can use the monitor as usual.

Specifications

Model	DT-V100CG
Type	Multi-Format Monitor
Picture Tube	10" measured diagonally
Effective Screen Size	Width :176.9 mm (6 15/16") Height :137.6 mm (5 3/8") Diagonal :224.5 mm (8 13/16")
Scanning Frequency	H : 15 kHz V : 50 Hz/60 Hz
Video Band	6 MHz (-3 dB)
Horizontal Resolution	Video: 280 TV lines 1080/60i: 230 TV lines
Input/Output Terminals	Composite signal input/output terminals VIDEO A/VIDEO B: 2 lines, BNC connector X 4 (1 Vp-p, 75 Ω) * The input (IN) and output (OUT) terminals are bridge-connected. (Auto termination) External synchronized input/output terminals EXT. SYNC: 1 line, BNC connector X 2 (0.3 Vp-p – 4 Vp-p, 75 Ω) * The input (IN) and output (OUT) terminals are bridge-connected. (Auto termination) Remote input/output terminals RS-485: Serial connection, 1 line, RJ-45 connector (8-pin) X 2, compliant to RS-485 MAKE/TRIGGER: Point-of-contact connection, 1 line, RJ-45 connector (8-pin) X 1
Compliant Video Signal	INPUT A/B: NTSC (3.58 MHz), PAL (4.43 MHz), B/W (50 Hz/60 Hz) INPUT C/D: Depends on the input unit (option) attached to the monitor. Refer to the input unit's manual for details.
Environmental Conditions	Operating temperature: 5°C – 35°C (41°F – 95°F) Operating humidity: 20% – 80% (non-condensing)
Power Requirements	120 V/220-240 V AC, 50 Hz/60 Hz
Power Consumption	0.9 A (120 V AC)/0.6 A (220-240 V AC)
Dimensions	Width: 222 mm (8 3/4") Height: 220 mm (8 3/4") Depth: 319.3 mm (12 5/8") (Dimensions are the same when the wide mask is attached. The input unit is not included.)
Weight	7.1 kg (15.7 lbs) (not including the wide mask and the input unit)
Accessory	AC power cord Power cord holder x 1 (case and cover) Screws x 2 (Power cord holder) Wide Mask x 1 Screws x 4 (Wide Mask)

* Illustrations and pictures used in this manual have been exaggerated, abbreviated or compounded for explanatory purposes only. The appearance of the actual product may differ slightly.

* Dimensions and weight are approximate.

* E. & O.E. Design and specifications subject to change without notice.

■ Dimensions

Unit : mm (inch)

Front View

(with the wide mask attached)

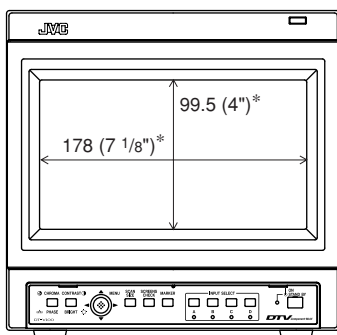

Front View

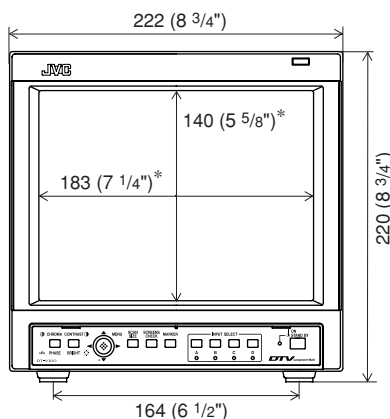

Side View

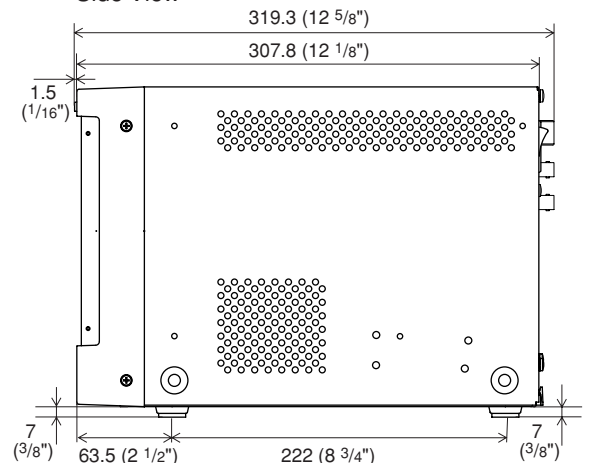

Asterisks(*) are used to indicate front panel dimensions.

JVC